

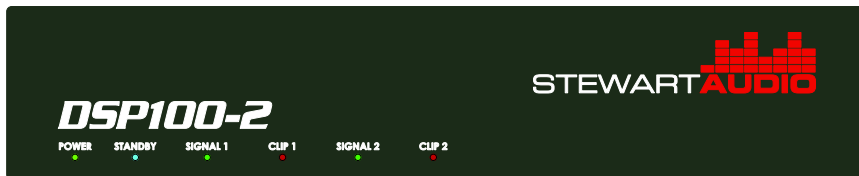

The Difference is Hear

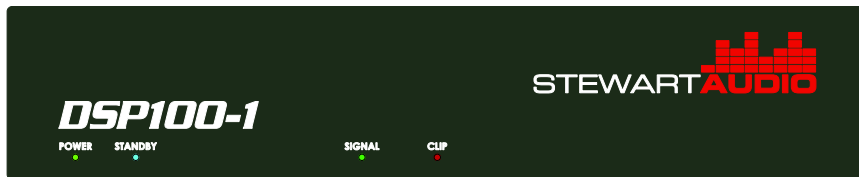

# DSP100 Series Owner's Manual January 2016

[www.stewartaudio.com](http://www.stewartaudio.com)

## Important Safety Instructions

Before using your Stewart Audio Inc. Power Amplifier, please read this **Owner's Manual** carefully to ensure optimum trouble-free performance.

**WARNING: TO REDUCE THE RISK OF ELECTRICAL SHOCK, DO NOT EXPOSE THIS AMPLIFIER TO RAIN OR MOISTURE. DANGEROUS HIGH VOLTAGES ARE PRESENT INSIDE THE ENCLOSURE. DO NOT OPEN THE CABINET. REFER SERVICING TO QUALIFIED PERSONNEL ONLY.**

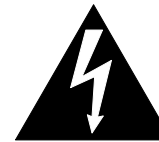
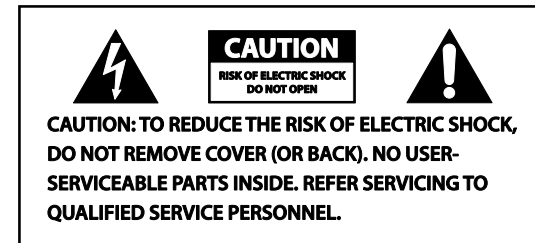

The lightning bolt within arrowhead symbol, within an equilateral triangle, is intended to alert the user to the presence of un-insulated "dangerous voltage" within the product's enclosure that may be of sufficient magnitude to constitute a risk of electrical shock to person.



The exclamation point within an equilateral triangle, is intended to alert the user to the presence of important operating and maintenance (servicing) instruction in the literature accompanying the appliance.

### Important Safety Instruction – Please Read Prior to Product Installation.

1. Installation should be performed by a trained and licensed professional to insure safe and lasting operation.
2. All of the safety and operating instructions should be read before the amplifier is installed or operated. Retain these instructions for future reference. All instructions should be followed; all warnings on the amplifier and in the operating instructions should be adhered to.

## Important Safety Instruction – Please Read Prior to Product Installation.

1. Read these instructions.
2. Keep these instructions.
3. Heed all warnings.
4. Follow all instructions.
5. Do not use this apparatus near water.
6. Clean only with dry cloth.
7. Do not block any ventilation openings. Install in accordance with manufacturer's instructions.
8. Do not install near any heat sources such as radiators, heat registers, stoves, or other apparatus (including amplifiers) that produce heat.
9. Do not defeat the safety purpose of the polarized or grounding-type plug. A polarized plug has two blades with one wider than the other. A grounding type plug has two blades and a third grounding prong. The wide blade or the third prong are provided for your safety. If the provided plug does not fit into your outlet, consult an electrician for replacement of the obsolete outlet.
10. Protect the power cord from being walked on or pinched particularly at plugs, convenience receptacles, and the point they exit from the apparatus.
11. Only use attachments/accessories specified by the manufacturer.
12. Use only with the cart, stand, tripod, bracket, or table provided by the manufacturer, or sold with the apparatus. When a cart is used, use caution when moving the cart/apparatus combination to avoid injury from tip-over.
13. Unplug this apparatus during lightening storms or when unused for long periods of time.
14. Refer all servicing to qualified service personnel. Servicing is required when the apparatus has ben damaged in any way, such as power-supply cord or plug is damaged, liquid has been spilled or objects have fallen into the apparatus, the apparatus has been exposed to rain or moisture, does not operate properly, or has been dropped.

## Table of Contents

Important Safety Instructions.....	2
Table of Contents .....	4
<b>1 Welcome</b> .....	5
1.1 Features.....	5
1.2 Using this Manual .....	5
<b>2 Setup</b> .....	6
2.1 Setup Precautions .....	6
2.2 Amplifier Installation.....	6
2.3 Proper Cooling Considerations .....	8
2.4 Input Connections .....	9
2.5 Output Connections .....	11
2.6 Network Connector.....	14
<b>3 Operation</b> .....	15
3.1 Operation Precautions .....	15
3.2 Model Configurations.....	15
3.3 Controls, Indicators, and Connectors .....	17
3.4 Dante.....	20
3.5 Remote Volume Control.....	22
<b>4 Troubleshooting</b> .....	23
<b>5 Technical Specifications</b> .....	24
<b>6 Warranty Information</b> .....	26
6.1 Warranty Summary .....	26
6.2 Return Procedure .....	26
<b>7 Accessories</b> .....	29
<b>8 Notes</b> .....	30



# 1 Welcome



Congratulations on the purchase of your new Stewart Audio DSP100 Series power amplifier. This amplifier has been designed and built to provide you with years of high-quality audio performance and trouble-free operation. If after reading this manual you should have any questions concerning amplifier installation and operation, please contact your Authorized Stewart Dealer, or you may contact us directly using the contact information provided on the back of this manual.

## 1.1 Features

The DSP100 Series of amplifiers are half-rack commercial amplifiers offering 100W of power per channel with integrated DSP. This unique combination of power and features allows these amplifiers to be tailored to the zone, application, room acoustics, and speakers saving time and budget. Your Stewart Audio DSP100 Series amplifier is the result of years of experience in the design and manufacture of quality amplifiers. As such it provides a combination of performance and operational benefits that simply cannot be found in conventional amplifiers.

- Dante interface available
- Integrated DSP for signal routing and filtering
- USB control and configuration
- Made in the USA

## 1.2 Using this Manual

In order to obtain maximum performance from your DSP100 Series Amplifier, please take time to read this brief owner's manual and carefully follow the guidelines for connection and operation.

This manual provides you with the information necessary to safely install and operate your new DSP100 Series amplifier in the most common scenarios. If you find yourself requiring additional assistance, please feel free to contact your Authorized Dealer, or you may contact us directly using the contact information provided on the back of this manual.

# 2 Setup

## 2.1 Setup Precautions



**CAUTION: Before installing your amplifier, make sure that you have read the Important Safety Precautions at the beginning of this manual.**

The amplifier should only be connected to 100/240 VAC, 50/60 Hz power supply. Do not defeat the ground or polarization of the power plug.

## 2.2 Amplifier Installation

Two rack mounting options are available for the DSP100 Series amplifiers. A single rack-mount kit provides for installation of a single DSP100 Series amplifier on a 1RU rack. The dual rack-mount kit provides for the installation of two DSP100 Series amplifiers side-by-side on a single rack.

### 2.2.1 Single Rack Mount Kit (Part Number RMK-HLF-S)

Assembling the single rack mount kit is straightforward. Attach each of the right-angle brackets by inserting the 2 screws through the bracket into the side of the FLX enclosure. Two straight brackets are also provided for the rear of the amplifier. The method of attaching these to the rack will depend on the type of rack you are using.

### 2.2.2 Dual Rack Mount Kit (Part Number RMK-HLF-D)

Refer to the figure on the following page when assembling the dual rack mount brackets onto the FLX amplifier.

**Step 1:** Note the position of the captive nuts on the inner brackets. One set must be near the front of one amplifier and the other set near the rear of one amplifier.

**Step 2:** Attach the right-angle brackets to the front of each amplifier and the flat brackets to the rear of each amplifier.

**Step 3:** Attach inner brackets to each amplifier as **oriented in step 1**. Insert and tighten two screws into the front of each inner brackets and two screws to the rear of each inner bracket.

**Step 4:** Bring the two subassemblies together, overlapping the flanges on the inner brackets. Both pairs of captive nuts should be inside the flange of the opposing bracket. Complete assembly by inserting two screws into the front of the pair of inner brackets and two screws to the rear pair of the inner brackets.

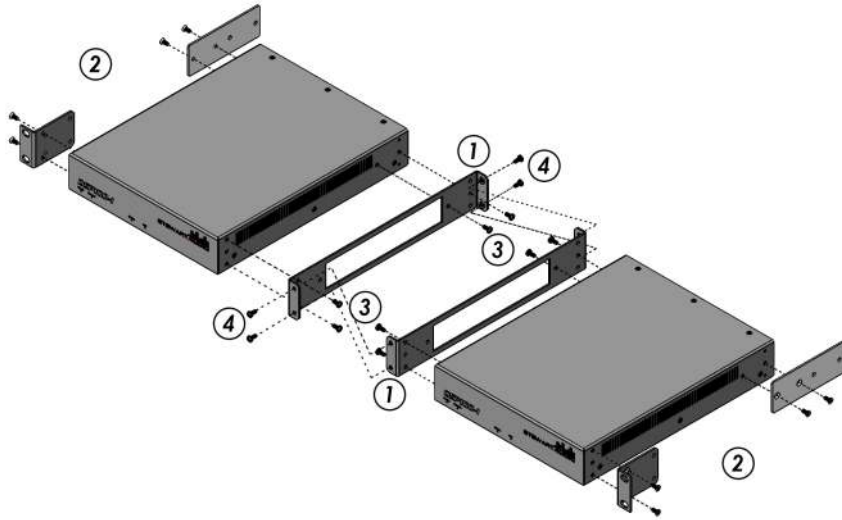

**CAUTION: Use only the screws provided in mounting brackets to the amplifier. Do not over tighten.**

## 2.2.3 Product Dimensions



## 2.3 Proper Cooling Considerations

Because the DSP100 Series amplifiers are convection cooled with no fans, amplifiers must be given adequate space to allow for proper airflow. Do not stack the amplifiers on top of each other or mount them in a way that other equipment will block airflow through the case.

Do not remove the feet on the base of the amplifier (unless rack mounting the amplifier). The amplifier must not be placed on a rug, bed, sofa or similar surface that impedes airflow across and /or under the chassis. Airflow through the ventilation openings should be unobstructed.

Do not place the amplifier in an enclosure (such as a NEMA enclosure) unless adequate cooling is provided.



**CAUTION: Inadequate airflow to the amplifier can cause the amplifier to overheat and potentially become damaged in the process. Be sure to provide plenty of air space to allow for convection cooling.**

## 2.4 Input Connections

Your DSP100 Series amplifier is provided with a removable five-pin 3.5mm terminal block connector for balanced (differential) inputs. Note carefully the polarity symbols on the rear of the unit, and that the two balanced inputs share a common ground connection. Two RCA jacks are also provided for unbalanced (single-ended) inputs. See the next three sections for instructions on connecting your amplifier to its input source.

The input sensitivity of the amplifier is  $1V_{rms}$ . For best sound quality, do not overdrive the amplifier

### 2.4.1 Balanced (Differential) Connections

When using a balanced input source and connector, you must ensure that the hot, cold, and ground pins of the connector are matched up to the +, -, and ground pins of the amplifier's connector respectively. Diagrams have been provided for standard XLR and TRS connectors.

Please refer to the manual of your input source in case it does not follow the standard pin-out.

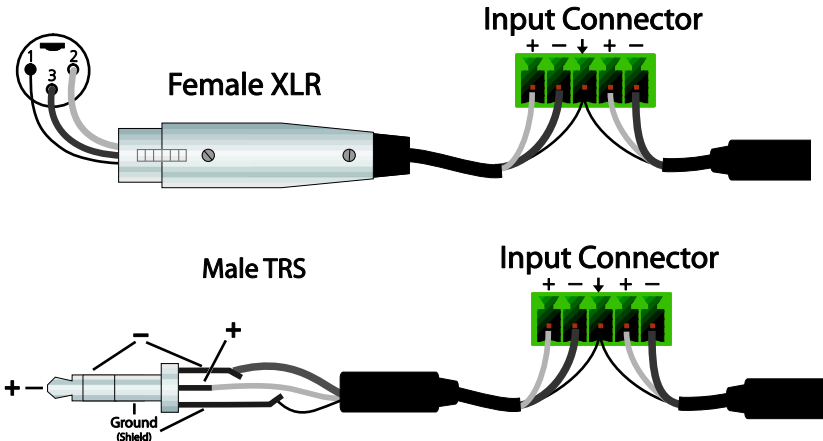

### 2.4.2 Unbalanced (Single-ended) Input Connections

Your DSP100 Series amplifier is provided with two RCA stereo connectors for unbalanced inputs (see diagram below).

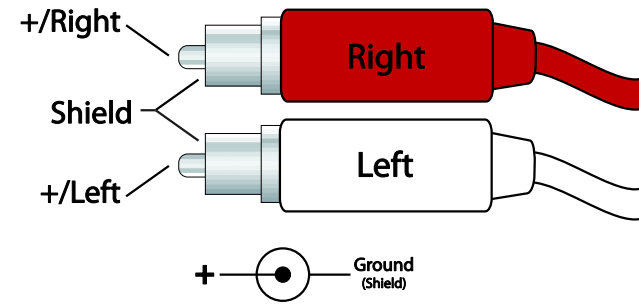

## 2.5 Output Connections

DSP100 Series amplifiers are available in both low impedance and constant voltage models. Please follow the instructions below based on your specific model.



The voltage on the amplifier output/speaker terminals is nominally 18VDC relative to the chassis or earth ground. Under no circumstances should either speaker terminal be connected to ground. This will cause a short circuit which may damage the amplifier. Similarly, do not connect any speaker terminals together. Use care when stripping speaker wires to ensure that all wire strands are properly inserted into the 5mm connectors and that no stray wires are allowed to contact other terminals, wires or the chassis. Do not remove excessive amounts of insulation from the wires as this may increase the likelihood of a short between wires or to the chassis.

### 2.5.1 Low Impedance (LZ) Models

Stewart Audio recommends using high-quality, heavy-gauge speaker wire and connectors to send the output signal of your amplifier to the speakers. Use the following table as a guideline when selecting your wire gauge.

Distance	Wire Gauge
Up to 25 ft.	16 AWG
26-40 ft.	14 AWG
41-60 ft.	12 AWG

Speaker leads connect by means of removable terminal block connectors supplied with the unit. Strip speaker leads 1/4" and insert into connector observing proper polarity. With a small, flat-blade screwdriver, tighten the screw until the leads are held securely in place. Inspect for possible shorts or broken wires.

Terminal Block Connector

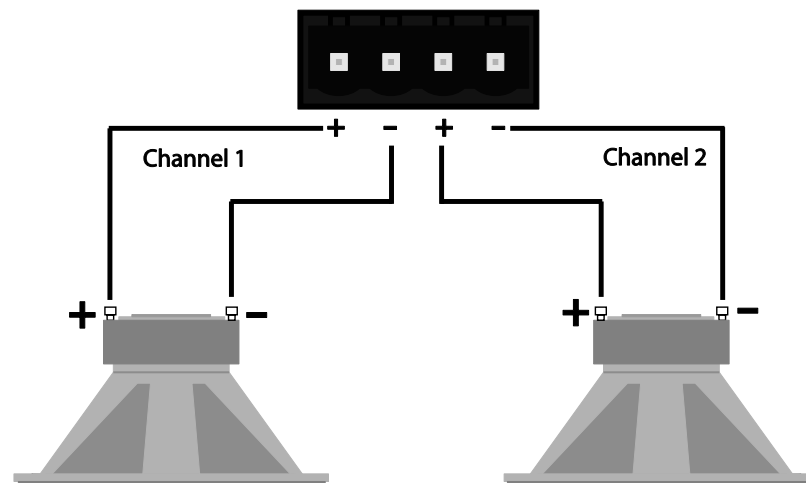

**CAUTION:** Do not connect either speaker terminal to ground. This will cause a short circuit which may damage the amplifier, speaker, or both. Similarly, do not connect any speaker terminal to ground.

### 2.5.2 High Impedance (Constant Voltage - CV) Models

Constant voltage amplifiers are designed to facilitate paralleling a number of high impedance speakers on a single output (channel). Ideally the output signal level is set to deliver nominally  $70V_{rms}$  ( $100V_{rms}$  in Europe) at the output terminals. Each speaker transformer is then appropriately tapped to deliver the required volume level for that speaker. Make certain that the total tapped power from all speakers connected to an output channel does not exceed the rated power of that channel. A good rule of thumb is to load the channel no more than 80% of rated power.

Care should be used when working around the speaker terminals. Though not officially recognized as a shock hazard in the UL 60065 Safety Requirements, touching these terminals can be quite unpleasant and should be avoided.

Because the current flow in constant voltage systems and speakers is much lower than in  $4/8\Omega$  systems, higher gauge (thinner diameter) wire can be used. Please refer to the following chart to choose the appropriate wire gauge for your installation.

Distance	Wire Gauge
Up to 500ft	22 AWG
500-1000 ft.	20 AWG
Over 1000ft	18 AWG

Speaker leads connect by means of removable terminal block connectors supplied with the unit. Strip speaker leads 1/4" and insert into connector observing proper polarity. For 70V systems, insert the speaker connectors between the **70V** and **COMMON** (indicated by a heavy "down" arrow) pins. For 100V systems connections insert the speaker connectors between the **COMMON** (indicated by a heavy "down" arrow) and **100V** pins. With a small, flat-blade screwdriver, tighten the screw until the leads are held securely in place. Inspect for possible shorts or broken wires.

**NOTE:** Class 2 wiring must be used on the speaker terminals to comply with UL requirements.

**CAUTION:** Do not connect either speaker terminal to ground. This will cause a short circuit which may damage the amplifier, speaker, or both. Similarly, do not connect any speaker terminal to ground.

**CAUTION:** The speaker terminals represent a shock hazard as they carry 70.7V and 100V when driven with an audio signal. Disconnect the amplifier from the AC power source when working on these terminals.

## Output Connector

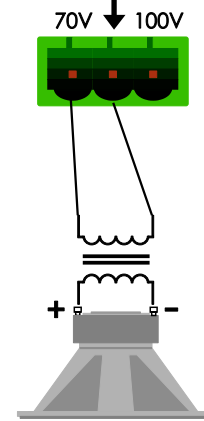

 = Step down transformer

## Output Connector

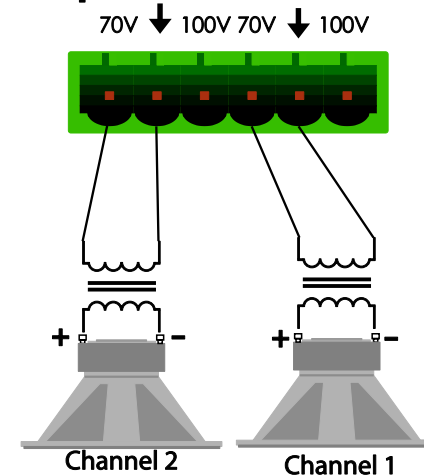

 = Step down transformer at each speaker

## 2.6 Network Connector

An RJ-45 connector is provided on Dante network enabled models. Connect this port to your audio transport network switch or router (see Section 3.4 Dante). Network and cable requirements are available from the Audinate web site at [www.audinate.com](http://www.audinate.com).

All network-enabled DSP100 Series amplifiers are shipped from the factory with *network* input 1 routed to *local* output 1 (via the internal DSP software mixer). The DSP100-2 model is shipped with network input 2 routed to local output 2. This can be changed as desired via the DSP Control Center software.

## 3 Operation

### 3.1 Operating Precautions

1. Before use, your amplifier must be configured for proper operation, including input and output wiring hookup. Improper wiring can result in damage to equipment or potentially harm to the operator. Consult Section 2 for setup instructions.
2. Tampering with the circuitry, or making unauthorized changes is not only dangerous but may also violate local regulations.
3. Use care when making connections between the amplifier and the input or output equipment. Using equipment that is not capable of handling the output wattage may lead to permanent damage.



**NOTE: Stewart Audio will not be held responsible for damage to your DSP100 Series amplifier or connected equipment if the instructions in this manual are not followed.**

### 3.2 Model Configurations

The basic features of each of the DSP100 models are outlined in the tables below and on the following page.

#### Non-Networked Models

	DSP100-1-CV	DSP100-2-CV	DSP100-2-LZ
Output Power per Channel	100W @ 70/100V	100W @ 70/100V	100W @ 4Ω
No. local Inputs	2 balanced / 2 single-ended	2 balanced / 2 single-ended	2 balanced / 2 single-ended
No. local Outputs	1	2	2
No. Network Inputs / Outputs	0/0	0/0	0/0



## Networked Models

	DSP100-1-CV-D	DSP100-2-CV-D	DSP100-2-LZ-D
Output Power per Channel	100W @ 70/100V	100W @ 70/100V	100W @ 4Ω
No. local Inputs	2 balanced / 2 single-ended	2 balanced / 2 single-ended	2 balanced / 2 single-ended
No. local Outputs	1	2	2
No. Network Inputs / Outputs	2/0	2/0	2/0

## 3.3 Controls, Indicators, and Connectors

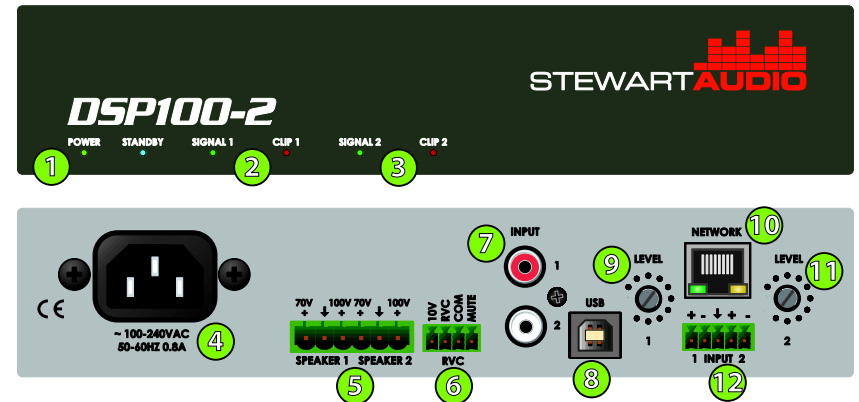

- 1 Power/Standby LEDs
- 2 Channel 1 - Signal/Clip LEDs
- 3 Channel 2 - Signal/Clip LEDs \*\*
- 4 Power Connector - IEC (Included)
- 5 Output Connections - 5mm
- 6 RVC Connector - 3.5mm
- 7 RCA Inputs
- 8 USB Programming Connector
- 9 Channel 1 Level Knob
- 10 Dante Network Connector (RJ45)
- 11 Channel 2 - Level Knob \*\*
- 12 Input Connections - 3.5mm

\*\* Not present on DSP100-1

### 3.3.1 Indicators

DSP100 Series amplifiers have 2 front panel LED indicators which illuminate to indicate when AC power is applied and the unit is operating (power), or when the amplifier is in “sleep” mode (standby). There is no power switch so the unit will remain on continuously when plugged in. Two additional LED indicators illuminate when an audio signal is present and when that signal is being clipped. The DSP100-2 models have an additional signal present LED indicator and an additional clip LED indicator for the second input channel.

### 3.3.2 Controls

DSP100 Series amplifiers have an integrated digital signal processor (DSP), providing considerable control of the audio signals. A set of DSP functions is available for each signal path. A powerful cross-point mixer provides a means of routing and mixing signals from the various inputs (both local and network) to the network and local outputs. The amplifiers are configured entirely via Stewart Audio’s DSP Control Center software via a USB link. The most current version of the Control Center software can be downloaded via the following link. (<http://www.stewartaudio.com/DSPCC>).

A flow chart of the DSP chain for each input and output is displayed on the following page. All network enabled DSP100 amplifiers have 2 local and 2 network inputs. The –1 models have one output and a single potentiometer for volume control, while the –2 models have 2 outputs and two potentiometers.

The cross-point mixer is shown below.

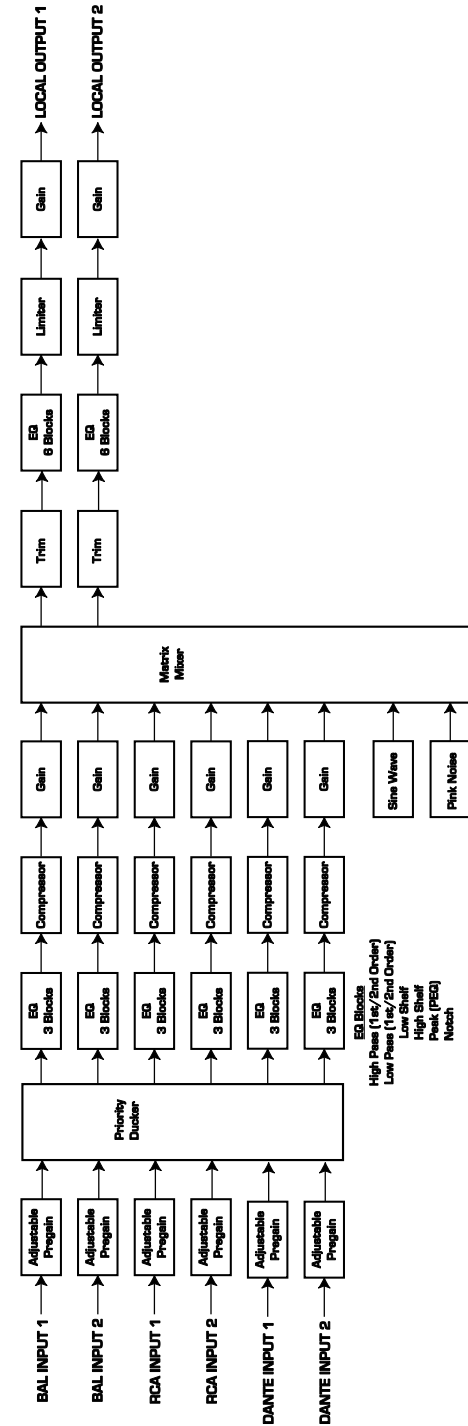
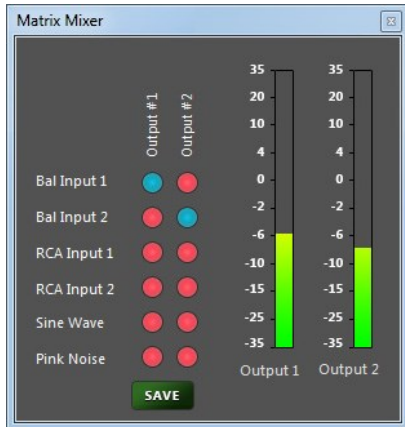

## 3.4 Dante

Your network enabled DSP100 Series amplifier can act as a network break-in box, as well as an amplifier with local inputs and outputs. Audio signal routing and configuration is done using the Dante Controller software from Audinate at [www.audinate.com](http://www.audinate.com).

Select “Dante Controller” under the Products section. This will require registration for Audinate’s portal and also includes access to the Dante Controller User Manual which should be read for complete configuration instructions.

### 3.4.1 Using Audinate’s Dante Controller Software

Once Dante Controller has been installed following the instructions in the Dante Controller Software User Manual ([www.audinate.com](http://www.audinate.com)), launch the application to see the connection matrix.

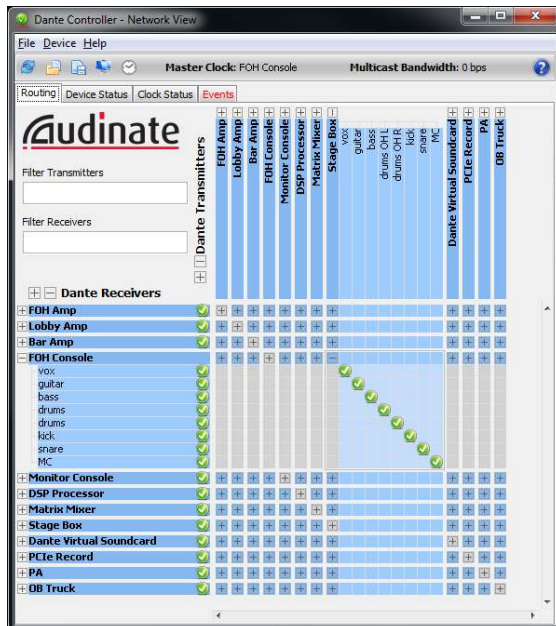

**All Stewart Audio products will ship from the factory with the name Ultimo-<MAC>. This can be renamed within the device configuration in the Dante Controller software.**

Transmitters are shown on the top of the matrix while Receivers are shown on the left-hand side. The DSP100 Series amplifiers include 2 receive channels. In order to make a connection, click on the matrix node between the appropriate transmitter and receiver. If a connection is successful, it will display a green checkmark.

**Note: All network-enabled DSP100 amplifiers are shipped from the factory with *network* input 1 routed to *local* output 1 (via the internal DSP software mixer). If the DSP100 model has more than one local output, the corresponding network input is routed to the local output with the same number designation. This can be changed as desired via the DSP Control Center software.**

### 3.4.2 Dante FAQ

*Q: I am having problems installing or using the Dante Controller Software.*

A: Please refer to the official documentation available in the Audinate portal where you downloaded the Controller Software.

*Q: I do not see the DSP100 Series amplifier showing up on the network?*

A: All Stewart Audio products are tagged as Ultimo-<MAC\_ADDRESS> from the factory. You can find a specific Ultimo device by choosing the device's MAC address from the list. You can rename this using the Dante Controller software.

*Q: I routed an audio signal to network input 1 of the FLX amplifier using the Dante Control Center software, but hear no output from the amplifier.*

A: Check the settings in the DSP100 amplifier matrix mixer (using the DSP Control Center software) to be certain that network input 1 is routed to a local output.

### 3.5 Remote Volume Control

The DSP100 Series amplifier can be remotely controlled by connecting an external potentiometer, (located up to 50' (15m) from the amplifier) between the +10V, RVC, and GND pins to rcontrol the output level of all channels or to mute all channels. (See diagram below.) Remote muting is useful for fire-alarm situations in which all unnecessary sound must be silenced.

**⚠ NOTE: The remote volume control connector attenuates the signal level set by the DSP settings. It cannot increase the signal level above those settings, nor does it change those settings.**

**⚠ NOTE: The remote volume control is disabled when the USB cable is connected to the device *even if a connection has not been established between the DSP Control Center and the device.* Remove the USB connector to use the remote volume control. It will remain at the last setting of the RVC until the USB connector is removed.**

In order to remotely control the volume of the unit, a 10k $\Omega$ , linear-taper potentiometer should be placed between the +10V pin and the GND (Ground) pin on the rear of the unit with its wiper on the RVC pin. The volume will be determined by the selected resistance on the potentiometer, the greater the resistance the louder the volume.

The amplifier can be remotely muted by making a connection between the GND pin and the MUTE pin. No power should be applied to these pins, simply a contact connection.

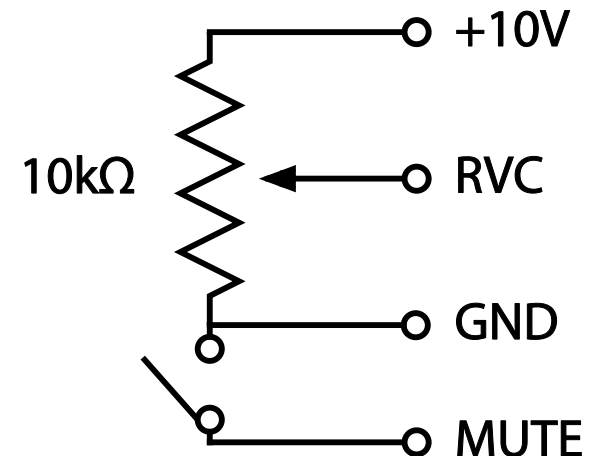

## 4 Troubleshooting

### **Problem: Power indicator does not turn on.**

**Procedure:** Check that the amplifier is plugged into a live outlet. After you have ensured that it is not a power issue, disconnect any speakers. If the amplifier turns on after a few seconds delay, then the problem is in the output connection. Check wiring and speakers for short circuits.

### **Problem: No output on one or both channels; Power indicator is lit.**

**Procedure:** Check that level controls are not turned down. Check that input and output connections are secure. Ensure signal present LED is flashing to denote a signal. If there is no signal detected check signal source and that level controls are set high enough.

### **Problem: Amplifier overheats and/or shuts off.**

**Procedure:** Review **Section 2.3** on proper cooling procedures. Check the signal lights on the rear of the amplifier to see if the signal is overdriving (the signal light flashes red frequently). Overdriving the amplifier for extended periods of time can cause a thermal shutdown.

### **Problem: Output sound is distorted or cracking.**

**Procedure:** Check all cables for damage or loose connections and reduce the gain on the input signal at the mixer or preamp level. Replace the cables and loudspeakers temporarily to see if this resolves the problem. If problem still exists, contact your Authorized Dealer for service.

### **Problem: RVC not responding.**

**Procedure:** The remote volume control is disabled when the USB cable is connected to the device *even if a connection has not been established between the DSP Control Center and the device*. Remove the USB connector to restore functionality.

### **Problem: I inadvertently overloaded the amplifier during setup and now it will not restart.**

**Procedure:** Unplug the AC power cord from the device and plug it back in. The amplifier will not automatically reset when the USB port is in use.

## 5 Technical Specifications

### **Output Power 30Hz - 20kHz**

DSP100-1-CV (-D)	100W x 1 @ 70.7/100V
DSP100-2-CV (-D)	100W x 2 @ 70.7/100V
DSP100-2-LZ (-D)	100W x 2 @ 4Ω

### **Frequency Response (+0, -3 dB)**

DSP100-1-CV (-D) and 100-2-CV (-D)	100Hz-20kHz
DSP100-2-LZ and DSP100-2-LZ-D	20-20kHz

**THD+N (@ full output power)** <0.1%

**Signal to Noise Ratio** >100dB

**Input Sensitivity** 1V (0 dBV)

**Input Impedance (Balanced/  
Unbalanced)** 7.2kΩ / 3.6kΩ

**External Mute** Contact closure

**Power Consumption: Idle; 1/8 Draw** 12W; 65W varies by model

**Amplifier Class** D

**Remote Volume** 0-10V

**Input Connectors** 3.5mm terminal block,  
dual RCA stereo

**Output Connectors** 5mm terminal block

**Dante Network Connector  
(-D models only)** RJ-45

**LED Indicators** Power, Standby, Signal, Clip

**Controls** USB, RVC

**Power Supply** Internal 110/240VAC 50-60Hz

Stewart Audio reserves the right to change features and specifications without notice.

<b>Cooling</b>	Convection-Cooling
<b>Construction</b>	Aluminum Chassis
<b>Mounting</b>	Rack-mounted
<b>Dimensions (height, width, length)</b>	1.7" x 8.4" x 10.7" 44mm x 212mm x 272mm
<b>Weight</b>	4.5 lbs max (varies by model)

Stewart Audio reserves the right to change features and specifications without notice.

## 6 Warranty Information

### 6.1 Warranty Summary

All Stewart Audio amplifiers and accessories, unless excluded in this summary, are covered by a 3-year limited warranty on parts and labor from the date of purchase. In order to be eligible for warranty repairs, the amplifiers and accessories must have been purchased through an authorized Stewart Audio dealer and submitted by the original purchaser. This warranty is only valid in the country in which the amplifier was purchased.

#### 6.1.1 Eligibility Requirements.

Stewart Audio warrants against all malfunctions which come as a result of component or manufacturer defect. The amplifier is also covered from all failures which arise during the warranty period (3 years from date of purchase) that are not a result of misuse. The following actions will void your warranty:

- The power cord or AC plug has been damaged through misuse.
- The amplifier has been exposed to moisture or extreme temperatures.
- The amplifier has been dropped, items have been dropped on the amplifier, or the enclosure has been damaged.
- The amplifier has been opened by the operator.
- The amplifier was improperly packaged when sending to the factory for repair, resulting in damage.
- Any of the precautions or instructions found in this manual were not followed.

Damages resulting to the amplifier which are not covered under this warranty can be factory-repaired at cost to the customer. Use the contact information below to initiate the repair process.

### 6.2 Return Procedure

This section includes the return procedures which must be followed in order to prevent processing delay or cost to the customer. Please read the entire section before contacting Stewart Audio for returns.

### 6.2.1 Return Authorization Number

All returns to the factory for service must be accompanied by a Return Authorization (RA) number. One can be obtained by contacting Stewart Audio at (209) 588-8111 or via e-mail at support@stewartaudio.com.

**NOTE: Any defective products received without an RA number will be returned to sender at their expense.**

If Stewart Audio is unable to contact the sender in 14 days, the merchandise will be considered scrap and may be disposed of.

### 6.2.2 Shipment Instructions

If Stewart Audio requests that you ship the defective product back to their service center, please refer to the guide below. To ensure prompt warranty service, be sure to follow all instructions.

1. Return Authorization (RA) is required for product being sent to the factory for service.
2. See packing instructions in **Section 6.2.3**.
3. Ship the defective product using a method which provides for order tracking or order confirmation. The service center is located at the following address:

Stewart Audio  
14335 Cuesta Court Suite C  
Sonora, CA 95370

4. Use a bold black marker and write the RA number on three sides of the box.
5. Record the RMA number for future reference. The RA number can be used to check the repair status.

### 6.2.3 Packaging Instructions

Should Stewart Audio request that you ship your product to their service center, these instructions must be followed in order to ensure safe delivery. If they are not followed, Stewart Audio assumes no responsibility for damaged goods and/or accessories that are sent with your unit.

### 6.2.3 Packaging Instructions (cont.)

1. Please write the RA number on three sides of the box. Include the Stewart Audio RA number inside the box and a brief description of the problem.
2. You will be advised during the RA process what accessories should be included with the amplifier (Power supplies, connectors, cords, etc.). This is dependent on the failure assessment.
3. When shipping your amplifier, it is important that it has adequate protection. We recommend you use the original packing material when returning the product for repair. If you do not have the original box, see number 4.
4. If you provide your own shipping pack, the minimum recommended requirements for materials are as follows:
  - a. 275 P.S.I. burst test, Double-Wall carton that allows for 2-inch solid Styrofoam on all six sides of unit or 3 inches of plastic bubble wrap on all six sides of unit.
  - b. Securely seal the package with an adequate carton sealing tape.
  - c. Do not use light boxes or "peanuts".

**NOTE: Damage caused by poor packaging will not be covered under warranty.**

### 6.2.4 Estimate Approval

An estimate for all non-warranty repairs will be provided to the customer once the unit has been shipped to the factory. The customer is responsible to approve this estimate within 7 days. If the repairs are not approved within 14 days, Stewart Audio reserves the right to consider the unit scrap and may discard it.

### 6.2.5 Payment of Non-Warranty Repairs

Payment for non-warranty repairs must be submitted to Stewart Audio before the product will be returned to the customer.

## 7 Accessories

The following accessories are available from Stewart Audio for your amplifier.

All part numbers shown are Stewart Audio Part Numbers.

### **Mounting Brackets**

RMK-HLF-S Single rack-mount kit for DSP100 Series amplifiers

RMK-HLF-D Dual rack-mount kit for DSP100 Series amplifiers

### **Wall Plates**

WP-RVC-B Wallplate with 10k potentiometer and knob for remote volume control (Black)

WP-RVC-A Wallplate with 10k potentiometer and knob for remote volume control (Aluminum)

**To purchase these accessories or to see the full Stewart Audio product lineup, visit us at:**

**[www.stewartaudio.com](http://www.stewartaudio.com)**

## 8 Notes

### **For Your Records**

In the spaces provided below, record the model and serial number located at the rear of your amplifier.

Model No. _____
Serial No. _____
Purchase Date _____

Retain this information for future reference.



## 8 Notes (Cont.)

## 8 Notes (Cont.)

## 8 Notes (Cont.)



14335 Cuesta Court  
Suite C  
Sonora, Ca. 95370

Phone: 209-588-8111  
Fax: 209-588-8113